



## **APPENDIX U**

Martha Pit Lake Management Strategy  
(AECOM)



# Martha Pit Lake Management Strategy

Martha Pit Lake - Modelling, Mitigation and Management  
Assessment

# Martha Pit Lake Management Strategy

Martha Pit Lake - Modelling, Mitigation and Management Assessment

Client: Oceana Gold

Co No.: 5719274

Prepared by

**AECOM New Zealand Limited**

Level 2, 2 Hazeldean Road, Addington, Christchurch 8024, P O Box 710, Christchurch MC, Christchurch 8140, New Zealand  
T +64 3 966 6000 F +64 3 966 6001 www.aecom.com

06-Jun-2018

Job No.: 60544823

AECOM in Australia and New Zealand is certified to ISO9001, ISO14001 AS/NZS4801 and OHSAS18001.

© AECOM New Zealand Limited (AECOM). All rights reserved.

AECOM has prepared this document for the sole use of the Client and for a specific purpose, each as expressly stated in the document. No other party should rely on this document without the prior written consent of AECOM. AECOM undertakes no duty, nor accepts any responsibility, to any third party who may rely upon or use this document. This document has been prepared based on the Client's description of its requirements and AECOM's experience, having regard to assumptions that AECOM can reasonably be expected to make in accordance with sound professional principles. AECOM may also have relied upon information provided by the Client and other third parties to prepare this document, some of which may not have been verified. Subject to the above conditions, this document may be transmitted, reproduced or disseminated only in its entirety.

## Quality Information

Document Martha Pit Lake Management Strategy

Ref 60544823

Date 06-Jun-2018

Prepared by Tim Mulliner

Reviewed by Ian Jenkins

## Revision History

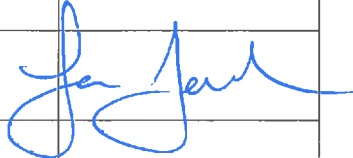
Rev	Revision Date	Details	Authorised	
			Name/Position	Signature
1	24-May-2018	Original	Ian Jenkins Technical Lead, Geochemistry	
2	6-June-2018	Header Updated	Ian Jenkins Technical Lead, Geochemistry	

## Table of Contents

Executive Summary		i
1.0	Introduction	1
	1.1	1
	1.2	1
	1.3	1
2.0	Pit Lake Treatment and Management Strategy	2
	2.1	2
	2.2	2
	2.3	2
	2.3.1	2
	2.3.2	3
	2.3.3	3
3.0	Pit Lake Geochemical Modelling	4
	3.1	4
	3.2	4
	3.2.1	5
	3.2.2	5
	3.2.3	5
	3.2.4	5
	3.3	10
	3.4	12
	3.4.1	13
	3.4.2	15
4.0	Conclusions	19
5.0	References	19
6.0	Limitations	20
Appendix A		
	Water Quality Inputs	A
Appendix B		
	Alkalinity Dosing System	B

## Executive Summary

Project Martha is a development proposed by Oceana Gold (New Zealand) Limited (OGNZL) that has the potential to extend the current life of mine from late-2019 to 2030. The project consists of the extension of the Martha Pit (Martha Phase 4 pit) and development of Martha Underground including the Rex vein.

OGNZL has engaged AECOM New Zealand Ltd (AECOM) to carry out geochemical assessment of the Martha Pit Lake based on the Martha Phase 4 pit profile, water balance and physical modelling results provided by others, and the pit lake management objectives. Appropriate pit lake attenuation and mitigation measures have been adopted to meet these objectives and form part of the pit lake management strategy.

The adopted pit lake management strategy has been developed in order to ensure that lake water quality is compliant with the conditions outlined in Discharge Consent 971293; to ensure that lake water quality is compliant with appropriate guidelines for recreational use; and is aesthetically acceptable within a reasonable time frame after lake filling. Where possible, mitigation measures that are self-sustaining or of low maintenance to minimise the long term financial liability have been adopted. The strategy developed, falls into three broad categories:

- Minimisation of acid rock drainage contribution to the lake.
- Modifying lake inflows during filling to increase alkalinity in the final lake at discharge.
- Increasing the alkalinity within the lake post filling to buffer against on-going acidity contribution.

Runoff from the exposed pit walls is estimated to contribute approximately 90% of the total acidity load to the pit lake. Therefore the minimisation of these acidity loads entering the lake will reduce the reliance on active treatment measures.

Diversion of the Ohinemuri River into Martha Pit will be utilised to speed up the filling process so that the lake is fully formed (to 1104 mRL) within an estimated 9.5 years. It is proposed to amend the Ohinemuri water take with limestone during discharge to the pit lake in order to buffer against the acidity load from the pit walls during filling.

Post filling, the active treatment of lake water via dosing with limestone is considered to be necessary in order to ensure discharge water is within the receiving water quality standards. However, depending on the rate of pit wall weathering and/or the success of pit wall acidity reduction, the reliance and/or requirement for active treatment in the long term could be minimised.

Geochemical modelling to assess geochemical reactions of the combined water qualities within the epilimnion of the pit lake was undertaken in the geochemical modelling software PHREEQC version 3.4.0, utilising the Minteq.v4 database. A series of conservative assumptions were adopted for the modelling process and iterations focussed on both pit-lake filling and post-filling, winter and summer stratification extremes, and short and long term discharge water quality.

The results of the modelling suggest that the adopted strategies are effective at meeting the management objectives and the water quality criteria for any discharge to the Mangatoetoe Stream. The long term need for active alkalinity introduction to the pit lake will depend on actual acidity load from the pit walls (which has been shown to diminish with time). However, the inclusion of an alkalinity dosing system is considered necessary to provide redundancy in the event that measures implemented to reduce the acidity load from the pit wall and/or the reduction in acidity load due to weathering, do not achieve acceptable water quality in the pit lake.

## 1.0 Introduction

### 1.1 Introduction

Project Martha is a development proposed by Oceana Gold New Zealand Limited (OGNZL) that has the potential to extend the current life of mine from late 2019 to 2030 by adding 0.7 million ounces of gold production to its Waihi operations. The project consists of two key components:

- The Martha Phase 4 pit; and
- The Martha Underground, including the Rex vein.

OGNZL has engaged AECOM New Zealand Ltd (AECOM) to carry out a revised geochemical assessment of the Martha Pit Lake based on the extension of the Martha Pit (Martha Phase 4 pit).

The purpose of this study is to determine the following, through assessment and predictive modelling in order to support the consenting process:

- Revise modelled water quality of pit lake based on proposed pit shell model and inputs from the revised hydrological and lake morphology studies.
- Assess appropriate pit lake attenuation and mitigation measures, if required.
- Present an overall management strategy.

### 1.2 Background

URS New Zealand (URS) has previously undertaken modelling of pit lake water quality on behalf of Newmont Waihi Gold Limited, with a number of iterations being carried out to date to refine prediction of water quality. This work has shown that the pit lake water will not meet the required quality standards without mitigation and/or management due to the ongoing acid contribution from the pit walls above the water level. The assessments included an evaluation of a number of mitigation measures to manage pit lake water quality to comply with the resource consent requirements. The pit lake assessments considered a range of scenarios including a conservative and best estimate of an un-mitigated lake and a range of mitigation options including improvement of run-off quality from potentially acid forming (PAF) areas, addition of alkalinity to river water, supplementation of lake water with treated mine water, and a combination of these. The current work outlined in this report builds further on the work previously undertaken utilising a more complex water balance and physical assessment prior to undertaking the geochemical assessment.

### 1.3 Report Structure

This report is structured in the following manner:

- Section 2: Pit Lake Management Strategy – describes the overall mitigation strategy based on the defined objectives.
- Section 3: Pit Lake Geochemical Modelling – describes the modelling process undertaken to assess water quality of resultant pit lake including derivation of water quality inputs.
- Section 4: Conclusions – Summarises the updated Martha Pit Lake assessment and management strategy.



## 2.0 Pit Lake Treatment and Management Strategy

Mitigation of the pit lake water quality to achieve appropriate water quality can readily be achieved through active treatment of the lake water, with this most likely comprising routine dosing of the lake water with alkalinity. Other strategies have, however, been considered as they provide benefits in terms of cost, long term sustainability and general acceptability to the public. These strategies fall into three broad categories.

- Minimisation of acid rock drainage contribution to the lake.
- Modifying lake inflows during filling to increase alkalinity in the final lake at discharge.
- Increasing the alkalinity within the lake post filling to buffer against on-going acidity contribution (default option).

These general strategies can be achieved through a number of methods at different stages of the pit lake life, and include pre-emptive mitigation measures to on-going management of lake quality. The options considered most likely to be feasible within the framework of adopted assumptions, constraints of the mine site and the end goal of lake quality mitigation have been adopted as the proposed mitigation options under the three categories listed above and are discussed in Section 2.3.

### 2.1 Water Quality Objectives

It has been estimated that lake filling, supplemented by water from the Ohinemuri River, will take in the order of 9.5 years to occur (GHD, 2018). On completion the lake level will be maintained at a level of 1104 mRL, with excess water discharged via an engineered outlet to the Mangatoetoe Stream. OGNZL holds consents for this on-going discharge to the stream (Discharge Consent 971293), with conditions of consent dictating a minimum standard for water quality. This will need to be re-consented as part of Project Martha. It is expected that any new resource consent will also require water quality to be monitored and managed to ensure that the discharge of water to the Mangatoetoe Stream is able to comply with the stipulated water quality criteria.

In addition, it is understood that OGNZL is committed to providing the Waihi Township a water body of sufficient quality as to constitute a recreational resource.

These water quality objectives are in general complimentary in that compliance with the consented discharge water quality will to a great extent result in an acceptable water quality for recreational use also.

### 2.2 Pit Lake Management Objectives

The objectives of the proposed management strategy are to:

- Ensure that lake water quality will comply with the existing water quality limits that apply to the discharge to the Mangatoetoe Stream.
- Ensure that lake water quality is compliant with appropriate guidelines for recreational use and is aesthetically acceptable.
- Where possible, employ mitigation measures that are self-sustaining or of low maintenance to minimise the long term financial liability of management.

### 2.3 Pit Lake Management Strategy

The pit lake management strategy is based on several mitigation efforts which focus on reducing pit inflow acidity and alkalinity addition in order to achieve the desired objectives.

#### 2.3.1 Minimisation of Acidity Load

The vast majority of the acidity load to the pit lake will come from runoff from areas of exposed unoxidised and partially oxidised PAF pit walls. Proportionally this accounts for a small volume of water within the pit lake water balance (ca. 3%), however due to the predicted acidity loads from this runoff it accounts for ca. 90% of the total acidity load.

Due to the physical nature of the pit walls themselves (steep in places) it is not considered practical to divert and/or treat all exposed faces in which elevated acidity is likely to be a source to the pit lake. However, it is generally understood that diversion and/or removal of any of the contributing inflows will have an overall impact on improving lake water quality as well as reducing the reliance on other mitigation strategies to neutralise the resultant pit lake acidity.

The upper levels of the north wall (>1104 mRL) are expected to be the significant contributor of acidity to the lake, with the area becoming the primary contributor of acidity post filling. Mitigation of flow from this area and/or minimisation of acidity from this area will minimise the long term net acidity inflow to the lake.

Actual mitigation could exist of one or a combination of the following:

- Diversion of flow away from areas of high acidity
- Diversion of flow from areas of high acidity to enable amendment prior to discharge
- Pit wall amendment
- Alkalinity amendment to benches and haul roads which will intercept runoff from areas of high acidity runoff

In addition it is probable that with time, the acidity load from the exposed pit walls will diminish as the exposed material becomes more weathered. This reduction in acidity due to weathering will occur regardless of any mitigation strategies employed.

No specific detailed measures for the reduction in acidity from the pit walls have been presented here, however a reduction in pit-wall inflow acidity has been modelled and presented to highlight the potential reduction in acidity and its effect on the water quality from both active (eg. Pit wall amendment), and/or long term weathering processes. It is recommended that specific measures to reduce this acidity load are explored further during the development of Project Martha.

### **2.3.2 Modifying Lake Inflows with Alkalinity**

To provide an adequate lake water quality on discharge the addition of alkalinity to the lake post filling will be required to mitigate the acidity contribution from the PAF areas of the pit walls.

#### **2.3.2.1 River Water Amendment**

During pit-lake filling, the dominant flow into the lake is the diversion flow from the Ohinemuri River. Under the currently consented abstraction rate, the river contribution is equivalent to an average of 9,000 m<sup>3</sup>/day, and this would increase to 15,000m<sup>3</sup>/day if the Project Martha water permit is granted. It is proposed that this flow be channelled into the pit by a method in which it can be entrained with alkalinity (eg. via the crusher slot and/or limestone rip rap on the haul road). Water will become saturated with alkalinity and discharge to the pit lake, providing buffering capacity within the lake water body. It is assumed that alkalinity equivalent of 60 mg/L bicarbonate will be added to the pit lake during filling via this method. Armouring of the limestone is not considered to be significant due to both the velocity of the river water and the total dissolved solids within the river water.

#### **2.3.3 On-going Manipulation of Lake Quality**

On-going manipulation of lake quality is likely to be required until the lake establishes a long term equilibrium that is acceptable both in terms of discharges and end use to the community. The inclusion of an active treatment system provides mitigation in case additional alkalinity is required within the lake water body. Its actual requirement would depend on the success of measures implemented that reduce the acidity load into the lake from the pit walls.

Previous work has suggested that the most effective and reliable solution is active addition of alkalinity to the lake water. This will allow buffering for ongoing inflow of acidic run-off from the pit walls. It is proposed that the alkalinity is introduced as limestone (CaCO<sub>3</sub>) via a dosing system where water is abstracted from the lake, dosed with CaCO<sub>3</sub> and then the slurry is discharged back into the lake in a manner that disperses this slurry. The limestone would be introduced as a slurry of fine powdered limestone which when injected into the pit lake will distribute throughout the water column and dissolve into a large volume of water enabling a large mass of limestone and alkalinity to be introduced into the pit lake. The use of limestone is assumed due to its reasonably low cost, ease of application, controlled pH levels that are moderately alkaline (pH 8.5) but not caustic, and effective alkalinity

introduction. Furthermore, the dosing rates will be able to be controlled within the operational constraints of the as-built system enabling dosing to be tailored to fluctuating pit lake water quality and in-flow acidity volumes. The actual dosing rates required would be dependent on the success reducing the pit wall acidity loading.

A conceptual design for the treatment system has been prepared previously and is provided in **Appendix B**. A conceptual diagram of the system is provided in Figure 1.

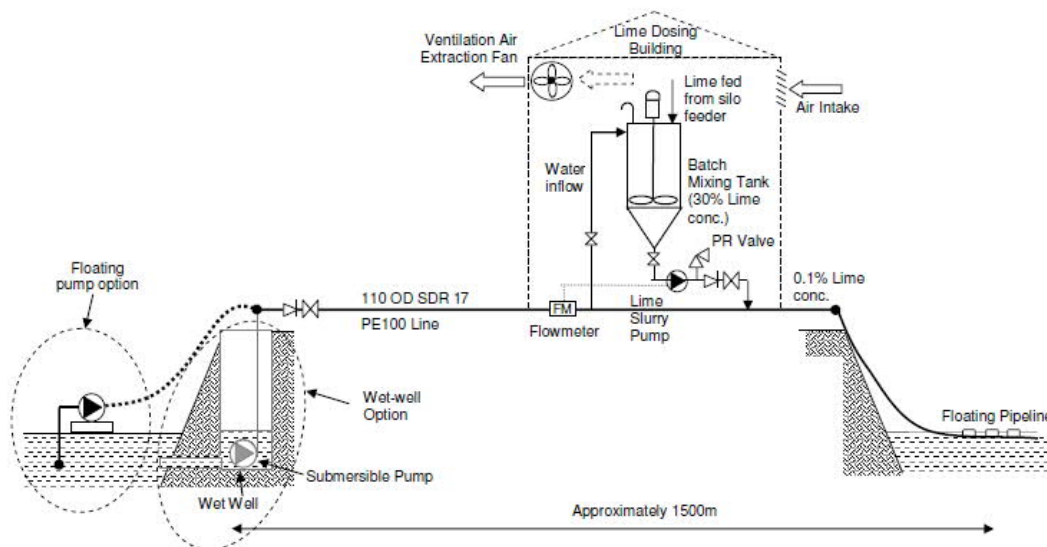

Figure 1 Conceptual Outline of Limestone Dosing System

## 3.0 Pit Lake Geochemical Modelling

### 3.1 Pit Lake Conceptual Model

The water balance and physical assessments of the pit lake (detailed in GHD, 2018 and HydroNumerics, 2018 respectively) describe the conceptual filling and water stratification models that are the basis for assessing and predicting the associated water quality.

The conceptual geochemical model incorporates:

- A water balance for water flowing to the pit from various sources.
- Discretisation of the pit wall by lithology, the quality of run-off produced, and elevation.
- Water quality for the water sources contributing to the lake.

### 3.2 Water Quality Inputs

The water quality adopted for each component of the water balance has been derived from available analytical data from the sampling programme undertaken on-site.

The analytical datasets varied in the number of samples, analytical suite and in the apparent statistical distribution of analyte concentrations due to differences in run-off quality as a function of differing temperatures, oxidation rates, leaching rates and dilution. Therefore several statistical distributions including the minimum, median, 25<sup>th</sup> and 75<sup>th</sup> percentiles and maximum have been adopted for each individual analyte in order to account for these variations. In general, the 50<sup>th</sup> percentile has been adopted for the modelling undertaken with sensitivity analysis undertaken using the wider spread of the dataset. The 50<sup>th</sup> percentile is considered applicable for use as the modelling focusses on the

entire volume of the pit lake at any one time and the mass as a total will be representative of the variable input water chemistries over time.

A brief summary of the adopted water qualities is outlined in Table 2. The full summary is shown in **Appendix A** and the four key water components that contribute to the lake filling and their data source are discussed below.

### 3.2.1 Groundwater

The groundwater level is currently maintained below the pit floor. On cessation of dewatering, groundwater will begin to flow into the pit, initially filling the voids (historical workings) and unsaturated backfill material before contributing to the lake volume. The current groundwater quality is represented by water quality samples collected from Shaft No.7 and is characterised by moderate acidity and dissolved solids, as is typical for groundwater from a mineralised fractured rock aquifer. It is considered that backfill in the underground workings is unlikely to be a source of oxidised products to groundwater due to compaction of the material upon deposition. In the event sulphides do oxidise within this material, it is unlikely to impact groundwater due to the current over saturation of sulphate and trace elements (AECOM, 2018). The current groundwater quality dataset is therefore considered to accurately reflect long term trends.

### 3.2.2 Rainfall

A theoretical chemistry for rainwater is adopted for the geochemical modelling. Whilst the dissolved solids content of rainwater is likely to have only minor impact on lake quality, rainwater chemistry is considered within the model as the lower than neutral, weakly buffered pH may have an influence on lake quality given the limited pH buffering in the pit lake inflows.

### 3.2.3 Ohinemuri River

Lake filling is to be supplemented by the pumping of Ohinemuri River water to the lake, with the intention of improving lake water quality and decreasing the fill time. Ohinemuri River water typically has neutral pH and low dissolved solids, with a sodium chloride chemical signature that reflects the near coastal source of surface water.

A representative chemistry for water diverted from the Ohinemuri River was determined from water quality samples obtained from sampling location OH3, up gradient of the tailings storage facility discharge point.

### 3.2.4 Pit wall run-off

Pit wall run-off will contribute a significant dissolved solids load to the pit lake, which decreases as the lake fills, owing to reducing pit wall surface areas with increasing lake level. Water chemistry of the run-off is dictated primarily by the mineralogy of the pit wall in the run-off flow path. Distinct differences in quality typically exist between water reporting to the lake over potentially acid forming (PAF) rock, such as material with argillic alteration, relative to water passing over non-acid forming (NAF) rock such as oxidised rock in the upper pit walls.

Key to the acid rock drainage process is the oxidation of sulphide minerals, producing sulphuric acid and releasing trace elements. During episodes of rainfall, rainwater leaches the oxidation products, forming an acidic solution that contains trace elements at potentially high concentrations. Where elevated sulphide concentrations are present in the pit walls rock (PAF rock), the run-off water quality is likely to be of low pH, high sulphate concentration and contain detectable levels of trace elements.

The degree to which pit wall rock is likely to be acid forming is dictated primarily by the minerals present, which is a function of pit wall lithology (alteration) and the degree to which the minerals have been oxidised. As such, the pit wall can be divided into areas referred to as pit wall associations that have a similar mineralogy and weathering profiles, and are found to generally produce a similar run-off chemistry. The areas defined as part of this study and their relative proportions throughout the pit wall are presented in Table 1.

**Table 1 Pit Wall Associations and Relative Proportions**

Section mRL	Oxidised	Partially Oxidised	Fresh PAF	Chlorite-Calcite	Post Mineralised
900 - 955	0.14	0.30	0.08	0.18	0.31
955 - 1005	0.15	0.25	0.08	0.19	0.34
1005 - 1055	0.18	0.21	0.07	0.15	0.39
1055 - 1104	0.22	0.16	0.10	0.10	0.43
>1104 (Post Filling Scenario)	0.32	0.07	0.09	0.03	0.48

Table 2 Summary of water qualities.

	Groundwater					Rainfall	Ohinemuri River				
<b>Sample Collection Dates</b>	10/08/1980	-		8/04/2011		-	24/01/2000	-		7/10/2015	
<b>Sample Count</b>	632					-	629				
<b>Sample Location IDs</b>	Shaft No 7					-	OH3				
	Min	25th %ile	Median	75th %ile	Max	Theoretical	Min	25th %ile	Median	75th %ile	Max
<b>Cations</b>											
Aluminium (g/m <sup>3</sup> )	<0.01	0.01	0.01	0.01	0.11	<0.01	0.01	0.02	0.03	0.08	0.55
Iron (g/m <sup>3</sup> )	0.003	0.04	0.40	2.32	224	<0.01	0.04	0.07	0.11	0.16	1.52
<b>Anions</b>											
Bicarbonate (g/m <sup>3</sup> at 25°C)	118	147	171	210	210	1.01	8.0	12.8	16.2	19.7	34.0
Chloride (g/m <sup>3</sup> )	<3	11	12	13	36	1	4.5	12.5	13.0	13.3	17.3
Sulphate (g/m <sup>3</sup> )	10	1,180	1,230	1,300	1,870	0.39	-5.0	4.0	4.8	6.7	1,300
<b>Properties</b>											
pH (pH units)	3.3	6.4	6.5	6.7	8.4	5.8	5.3	6.9	7.2	7.4	8.7
Electrical Conductivity (EC) (mS/m)	15	211	222	231	298	0.40	3.4	8.3	8.6	9.1	238
Alkalinity-Total (g/m <sup>3</sup> as CaCO <sub>3</sub> )	3	143	160	171	1,530	0.83	2	10	14	17	275

	Pit Wall Run-Off														
	Post Mineralisation Association					Oxidised Association					Partially Oxidised PAF North Wall				
Sample Collection Dates	6/03/2008	-		17/04/2014		6/03/2008	-		15/05/2015		15/11/2004	-		15/05/2015	
Sample Count	81					193					140				
Sample Location IDs	PM1-PM3					O1-O4					NU1, NU2, NU4, N1, N2				
	Min	25th %ile	Median	75th %ile	Max	Min	25th %ile	Median	75th %ile	Max	Min	25th %ile	Median	75th %ile	Max
<b>Cations</b>															
Aluminium (g/m <sup>3</sup> )	0.23	0.37	0.42	1.27	14.80	0.03	0.07	0.11	0.33	1.08	3.40	8.73	15.6	30	300
Iron (g/m <sup>3</sup> )	<0.02	0.04	0.10	0.18	0.92	<0.02	0.03	0.05	0.08	0.88	0.68	23	86	339	1,520
<b>Anions</b>															
Bicarbonate (g/m <sup>3</sup> at 25°C)	3.30	4.83	5.35	6.23	11.80	1.30	3.70	6.30	8.95	40	<0.01	<0.01	<0.01	<0.01	<0.01
Chloride (g/m <sup>3</sup> )	1.50	5.98	8.00	9.83	39	0.88	5.20	8.00	13.20	240	<0.01	3.20	4.80	7.55	22
Sulphate (g/m <sup>3</sup> )	0.80	8.45	15.85	34	105	0.50	3.10	4.50	7.05	143	<0.01	370	2,230	5,585	52,400
<b>Properties</b>															
pH (pH units)	3.60	5.50	6.00	6.30	7.30	4.30	5.20	5.60	6.20	8.00	2.10	2.70	2.90	3.10	6.80
Electrical Conductivity (EC) (mS/m)	1.40	5.80	8.50	13.40	31	1.20	3.45	5.00	7.90	118	<0.01	82	151	263	899
Alkalinity-Total (g/m <sup>3</sup> as CaCO <sub>3</sub> )	<2.00	2.70	4.00	6.40	53	<2.00	2.00	2.90	4.70	120	<1.00	<1.00	<1.00	<1.00	135

	Pit Wall Run-Off					Fresh PAF South Wall				
	Chlorite - Calcite									
<b>Sample Collection Dates</b>	12/07/2008	-		16/03/2015		16/06/2008	-		17/06/2014	
<b>Sample Count</b>	31					59				
<b>Sample Location IDs</b>	NU3, NU5					SU1				
	<b>Min</b>	<b>25th %ile</b>	<b>Median</b>	<b>75th %ile</b>	<b>Max</b>	<b>Min</b>	<b>25th %ile</b>	<b>Median</b>	<b>75th %ile</b>	<b>Max</b>
<b>Cations</b>										
Aluminium (g/m <sup>3</sup> )	0.01	0.01	0.01	0.01	7.00	19	44	114	160	200
Iron (g/m <sup>3</sup> )	<0.10	<0.02	<0.02	<0.02	<0.02	121	423	760	1,400	3,600
<b>Anions</b>										
Bicarbonate (g/m <sup>3</sup> at 25°C)	<0.01	<0.01	<0.01	<0.01	<0.01	1.00	1.00	1.00	1.00	1.00
Chloride (g/m <sup>3</sup> )	1.30	4.3	5.4	8.6	33	1.70	3.85	7.1	10	21
Sulphate (g/m <sup>3</sup> )	48	78	160	240	380	700	2,325	5,000	9,075	17,000
<b>Properties</b>										
pH (pH units)	3.30	6.75	7.10	7.40	7.90	2.10	2.40	2.40	2.50	6.60
Electrical Conductivity (EC) (mS/m)	17.10	40	62	83	228	52	273	374	559	899
Alkalinity-Total (g/m <sup>3</sup> as CaCO <sub>3</sub> )	20	24	25	32	100	<1.00	<1.00	<1.00	1.00	1.00



### 3.3 Overview of Water Balance and Physical Modelling

The overall water balance of the lake, which takes into account the filling of the underground workings, was undertaken in the software Goldsim and is reported in GHD, 2018. Output from water balance modelling was processed in the Aquatic Ecosystem Model 3D (AEM3D) which predicts velocity, temperature and salinity distribution in natural water bodies and provides an estimation of lake stratification and turn over. The physical modelling process also took into account the total dissolved solid (TDS) contribution of the various flow inputs which was calculated from the water quality data outlined in Table 2. The physical modelling and results undertaken are outlined in HydroNumerics, 2018. The conceptual outline of the modelling undertaken in association with the Martha Pit Lake is summarised in Figure 2. The results of this physical assessment have been provided to AECOM and are the basis for the geochemical assessment.

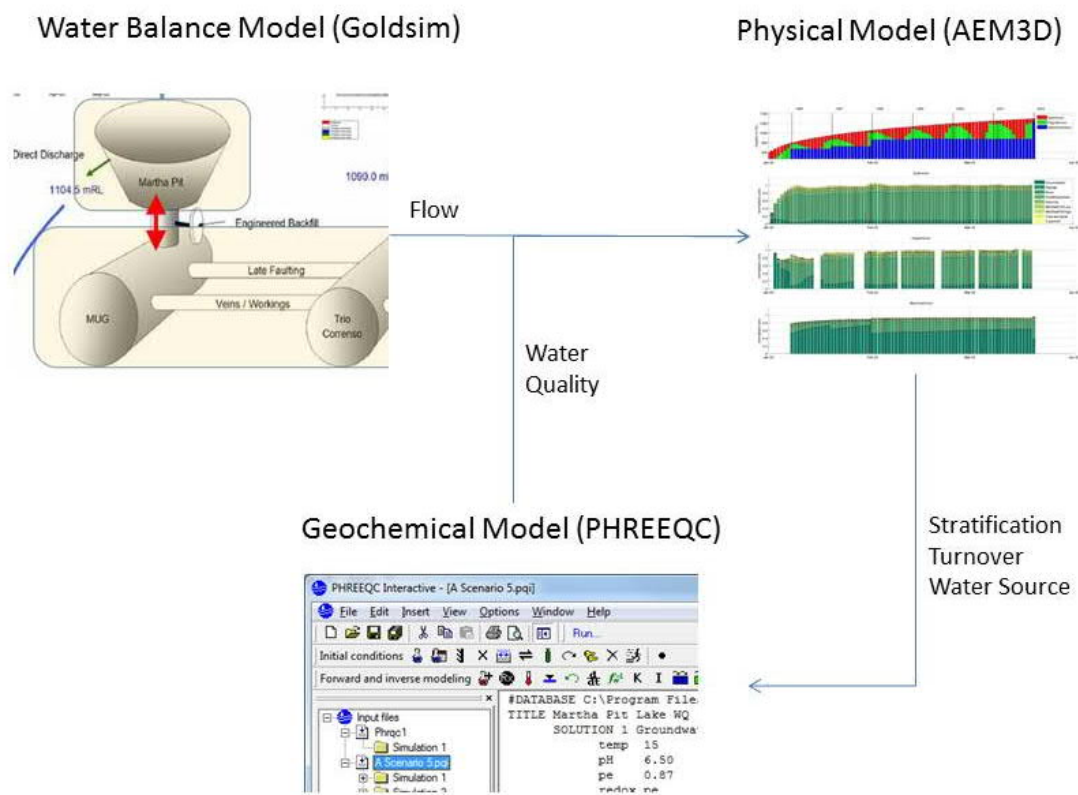

**Figure 2 Conceptual Outline of Martha Pit Lake Modelling Process**

The physical modelling results and selected scenarios for the geochemical assessment are summarised visually in Figure 3. The selected scenarios (detailed in Table 3) focus on snapshots in time to conservatively represent filling (Scenario A & B) and post filling (Scenario's C to F). All scenarios have been selected so that the greatest relative proportion of runoff from high-PAF pit walls is selected for both pit-lake filling and post-filling, winter and summer stratification extremes, and short and long term discharge water quality. These selected scenarios are considered to represent the worst case in terms of the epilimnion geochemical water quality.

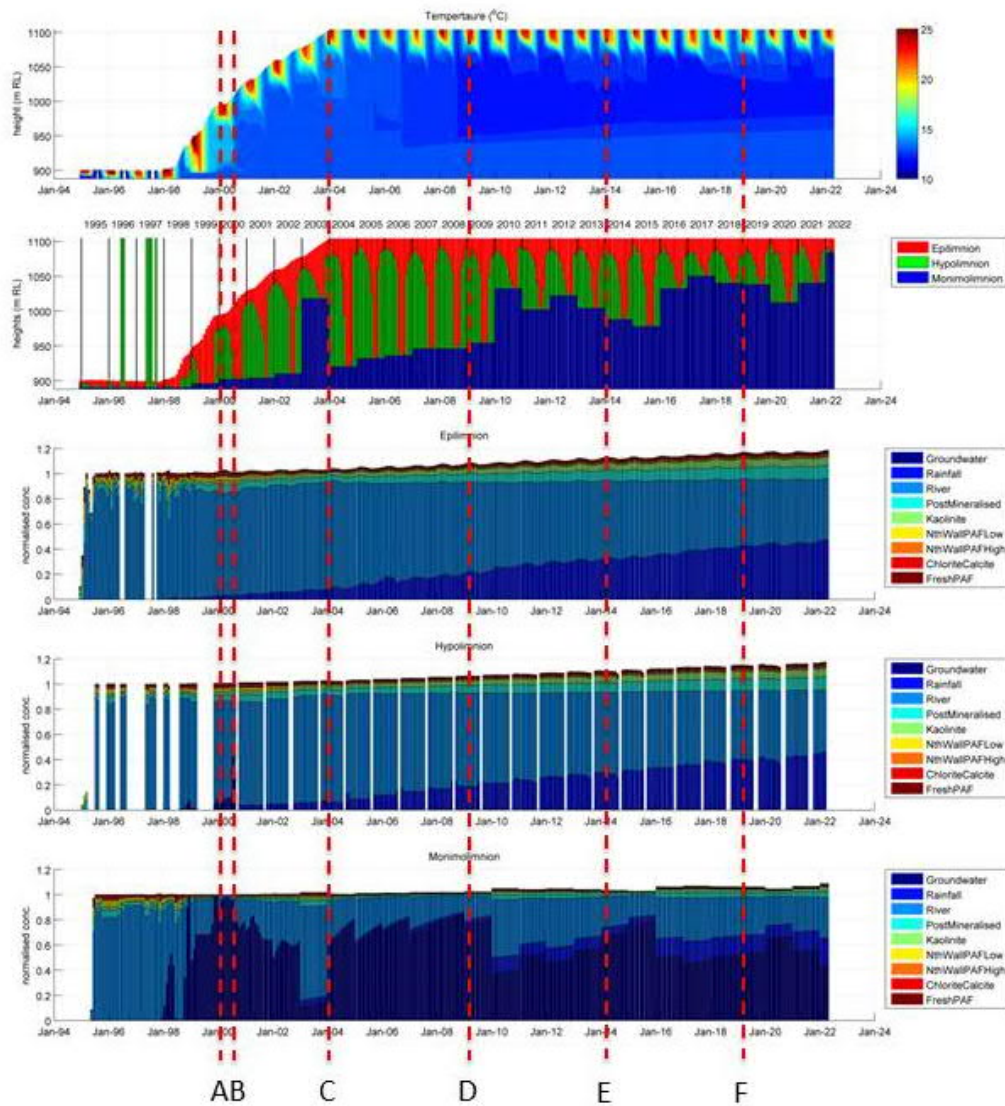

Figure 3 Physical Modelling Output and Selected Scenarios for Geochemical Modelling

Table 3 Geochemical Modelling Scenarios

Scenario	Model Date**	Post Closure Year (ie. Years after filling commenced)	Description of Scenario	Groundwater	River	Rainfall	Pit Wall Run-off - Alteration Type				
							Post Mineralised	Oxidised	Partially Oxidised PAF	Chlorite-Calcite	Fresh PAF
A	Jan-00	4.5	Filling (Summer)	<0.01	0.80	0.04	0.07	0.03	0.04	0.03	0.02
B	Aug-00	4.75	Filling (Winter)	<0.01	0.82	0.03	0.06	0.03	0.03	0.02	0.02
C	Jan-04	9	Initial Discharge	<0.01	0.85	0.09	0.04	0.02	0.01	0.01	0.01
D	Jan-09	14	Discharge	<0.01	0.72	0.21	0.07	0.04	0.01	0.01	0.02
E	Jan-14	19	Discharge	<0.01	0.63	0.32	0.08	0.05	0.01	0.01	0.03
F	Jan-19	24	Discharge	<0.01	0.53	0.42	0.10	0.06	0.01	0.01	0.03

\*Numbers show contribution proportion from various water sources. Proportions do not necessarily add up to 1 due to the mass conservative nature of the physical modelling process and loss of water through evaporation.

\*\*Stated dates are indicative of recorded and extrapolated metrological data that have been used in the physical assessment and do not represent the actual predicted year.

### 3.4 Lake Water Quality Modelling

Lake water quality modelling was undertaken utilising the geochemical modelling software PHREEQC version 3.4.0 and the Minteq.v4 database. PHREEQC is utilised to assess geochemical reactions of the combined water qualities within the morphological layers of the pit lake in order to account for and assess overall pit lake water quality that a mass balance approach will not take into account.

Water within the epilimnion is the focus of the geochemical modelling as it is reflective of discharge and 'contact' water. Water contained within the epilimnion is considered to equilibrate with CO<sub>2</sub> in the atmosphere and precipitation of the appropriate oversaturated species is allowed for within the modelling.

Assumptions and limitations of the modelling are as follows:

#### **Pit Wall Lithology**

The relative proportion of lithology's and alteration types in the andesite rock around the new Phase 4 pit shell are considered to be approximately equivalent to that previously mapped for the purposes of the assessment. It is possible (based on recent visual assessment of the Northern Wall) that the final exposed surfaces of the northern wall will be less acid producing compared to the current assumed lithology's and alteration types. However this potential reduction has not been taken into account in this assessment. The assumed proportion of areas for both the filling and post filling scenarios are provided in

Table 1. This is a key assumption of the assessment of pit lake quality and the proposed mitigation options.

### ***Pit Wall Interactions***

Interactions of lake water with the submerged surface of the pit are not considered in the modelling of Pit lake quality. A small quantity of minerals will continue to be leached from the rock surface once submerged, however, it is considered likely that this will have only a minimal impact on the lake quality for the following reasons:

- With the exception of upper layers in the lake, the lake water will be oxygen deficient, limiting the potential for oxidation and leaching from the pit walls.
- In the upper layer of the lake, the oxidation of sulphides within the pit walls due to dissolved oxygen in the water column would be minimal compared to oxidation in the non-saturated pit walls.
- With the pit wall surface area being small relative to the lake volume, it is likely that any leaching that does occur will have minimal effect on the lake water quality as a whole.

As such, the interactions between lake water and the submerged pit walls have been excluded from the model.

### ***Precipitate Adsorption***

Oversaturated species precipitating from lake water, particularly metal oxyhydroxides, offer sorption sites for dissolved trace elements. These precipitates would ultimately settle at the base of the lake in the monimolimnion and become unavailable for remobilisation. Under typically oxidising conditions this results in the attenuation of metal concentrations, however, these processes have only been considered for comparative purposes to provide a best estimate comparison to the worst case considered in this assessment (ie. no sorption). The conservative approach employed here and considered in the physical assessment which was mass conservative, was undertaken for the following reasons:

- While oxyhydroxide precipitates are expected within the lake, their spatial presence may be localised and as such the potential attenuation of aqueous phase trace elements by adsorption to these minerals may be limited.
- In the absence of empirical data for the Pit Lake water it is difficult to estimate the proportion of precipitate sorption sites available for metal adsorption. It is possible that if adsorption were considered, the modelled results would be less conservative than appropriate.
- The Pit Lake environment is dynamic, and whilst the sorption of trace elements onto oxyhydroxides may occur near the surface where oxidising conditions prevail, desorption may occur as precipitates sink through the water column. Lake mixing, despite the modelled presence of a permanent monimolimnion could result in redistribution of these species.

### ***Acidity loading of Pit Wall runoff***

Model scenarios where a reduction in Fresh PAF are included for comparative purposes only. The management strategy presented assumes that the acidity sourced from the pit-wall runoff is constant and no account is taken for reduction of the acidity load with time as the fresh pit walls become weathered. The results are therefore considered conservative with regards to the long term pit wall acidity contribution.

Based on these assumptions and the selected scenarios, the geochemical modelling presented here provides a conservative assessment of the predicted lake water quality post closure.

#### **3.4.1 Short Term Lake Water Quality (During Filling).**

Two modelling scenarios are presented for the lake filling stage representing both summer (Scenario A) and winter (Scenario B). Data from modelling year 2000 (during the 4<sup>th</sup> year of filing) was selected

as results from the physical assessment showed the proportion of high PAF pit wall runoff within the epilimnion was the highest during this year. The key mitigation assumed for the filling scenarios are outlined in Table 4.

**Table 4 Scenarios Modelled for Filling Stage**

	Scenario A	Scenario B
Alkalinity in River Water	Y	Y

Results for the two modelled filling scenarios are presented in Table 5. Results are based on alkalinity amended river water making up the bulk of the water flow inputs with an average addition rate of 15,000 m<sup>3</sup>/day reflective of the proposed take from the Ohinemuri River (GHD, 2018). This provides a large buffering capacity against the acidity loads from the pit walls.

The results suggest that water quality in the epilimnion will generally be improved in winter months when the monimolimnion is at its greatest. This is due to the increased dilution of the high acidity pit wall runoff with the amended river water. The receiving water quality standards are in effect not valid for the filling stage, however for sake of comparison to the modelled receiving water quality standards, the epilimnion would meet the discharge criteria (without appropriate mixing) for most elements. Notable exceptions are the pH during the summer epilimnion minimum and copper for both the summer and winter scenarios.

**Table 5 Lake Filling Geochemical Modelling Results**

	Filling - Summer	Filling - Winter	Receiving Water Quality Standards**
	Scenario A	Scenario B	Hardness
	+ Alkalinity in River Water		100 mg/L CaCO <sub>3</sub>
pH	6.1	7.3	6.5 - 9.0
Al	0.036	0.001	
As	0.004	0.004	0.19
Ca	55	57	
Cd	0.0002	0.0002	0.001
Co	0.021	0.017	
Cr <sup>##</sup>	0.010	0.009	0.01
Cu	0.016	0.013	0.011
Fe	0.006	0.0003	1
Hg <sup>#</sup>	<0.0001	<0.0001	0.000012
K	0.4	0.8	
Mg	5.9	5.4	
Mn	0.50	0.45	2
N	0.454	0.464	
Na	48	41	
Ni	0.044	0.036	0.16
P	0.077	0.067	
Pb	0.0001	0.0001	0.0025
S	154	131	
Sb	<0.001	<0.001	

	Filling - Summer	Filling - Winter	Receiving Water Quality Standards**
	Scenario A	Scenario B	Hardness
Se	0.001	0.001	0.02
Si	8.8	9.0	
Zn	0.038	0.032	0.1
TDS (Calculated)	266	238	
Hardness (mg/L CaCO <sub>3</sub> )	162	164	

\*All results reported in mg/L except pH (pH units)

\*\*The receiving water quality standards are hardness dependant and allow for an appropriate dilution following discharge. For purposes of comparison (as the pit lake will not discharge during the filling period), the standards given assume a hardness of 100 mg/L and are provided here as reference only.

#Detection limit of raw data is higher than receiving water quality standard

##Modelled concentrations are based on Cr(III) and Cr(VI). Receiving water standard is based on toxic form only (Cr(VI)).

### 3.4.2 Long Term Lake Quality (Post Filling)

Seven modelling scenarios are presented for the post lake filling stage, the basis for each scenario and key mitigation assumed is outlined in Table 6.

Table 6 Scenarios Modelled for Post Filling Stage

	Scenario C	Scenario D (1)	Scenario E(1)	Scenario F(1)	Scenario D (2)	Scenario E(2)	Scenario F(2)	Scenario F(3)
Alkalinity in River Water	Y	Y	Y	Y	Y	Y	Y	Y
Reduction in Pit Wall Acidity Load	N	Y	Y	Y	N	N	N	N
Pit Lake Amendment	N	N	N	N	Y	Y	Y	Y
HFO Formation	N	N	N	N	N	N	N	Y

Results for the predicted long term lake epilimnion water quality which is also reflective of the discharge water quality are presented in Table 7. All scenarios outlined assume that alkalinity amended river water is the primary water input during the pit lake filing period. When the pit lake reaches its maximum level (1104 mRL) the river diversion is terminated. The river water (present within the pit lake from the diversion period) still provides buffering to the acidity from the pit walls after the pit reaches its spill point although this buffering effect diminishes with time as water from the diversion is 'lost' to the hypolimnion and monimolimnion, to evaporation, and also within the lake discharge. Scenarios D to F (which are reflective of discharge pit lake water quality at 5, 10 and 15 years post filing) require either a reduction in the acidity load from the exposed pit walls (Scenarios D1, E1 and F1) or pit lake amendment via an alkalinity dosing system operating when and as required (Scenarios D2, E2 and F2).

The results in Table 7 show that the modelled water quality meets the receiving water quality standard based on assumed hardness of 100 mg/L. There are two exceptions to this in Scenario F(2) which gives a modelled discharge concentration of Cr and Cu of 0.012 and 0.013 mg/L respectively. These concentrations marginally exceed the appropriate receiving water quality standard at a hardness of 100 mg/L. The scenario in question is based on pit lake amendment via an alkalinity dosing system which would increase the hardness in the discharge to a calculated 200 mg/L. With this in mind and

assuming a linear relation in hardness adapted receiving water quality criteria, the relevant criteria for Cu would be 0.021 mg/L which is above the modelled concentrations. For chromium, the modelled concentrations are based on both Cr(III) and Cr(VI), however the receiving water quality standard (not hardness related) is based only of the toxic form (Cr(VI)). Bearing this in mind, and the fact that no mixing zone is modelled, the given mitigation measures (alkalinity dosed river water coupled with either a reduction in the pit wall acidity load (Scenario F1) or active alkalinity amendment (Scenario F2)) are considered adequate measures to ensure compliance with the receiving water quality standards and ensure a pit lake that is suitable for recreational purposes.

Furthermore, when the possibility of HFO formation is taken into account (Scenario F3) modelled concentrations for a number of trace elements (eg. As, Cd, Co, Cr, Cu, Hg, Ni, Pb, Se and Zn) attenuate via co-precipitation and ultimate settlement reducing modelled trace element concentrations significantly. However, as outlined in Section 3.1, HFO formation may be localised and it is difficult to estimate the proportion of precipitate sorption sites available for metal adsorption. Therefore the modelling undertaken in Scenario F4 is considered the theoretical best case scenario. In reality concentrations of these trace elements in the pit lake (under the assumptions and conditions outlined) are likely to fall somewhere between those given in scenario F2 (no HFO formation) and scenario F3 (HFO formation with unlimited sorption sites).

Table 7 Lake Discharge Geochemical Modelling Results

	Discharge – Year 0	Discharge – Year 5	Discharge – Year 10	Discharge – Year 15	Discharge – Year 5	Discharge – Year 10	Discharge – Year 15	Discharge – Year 15	Mangatoetoe Receiving Water Quality Standards**
	Scenario C	Scenario D (1)	Scenario E(1)	Scenario F(1)	Scenario D (2)	Scenario E(2)	Scenario F(2)	Scenario F(3)	Hardness
	Alkalinity in River Water	Alkalinity in River Water + Acidity Reduction in Fresh PAF			Alkalinity in River Water + Pit Lake Amendment			Alkalinity in River Water Pit + Lake Amendment + HFO Formation	100 mg/L CaCO <sub>3</sub>
pH	7.6	7.8	7.7	7.5	8.4	8.3	8.2	7.0	6.5 - 9.0
Al	0.0002	0.003	0.003	0.002	0.011	0.010	0.008	0.075	
As	0.003	0.001	0.001	0.001	0.004	0.005	0.005	<0.001	0.19
Ca	53	48	43	39	87	82	77	37	
Cd	<0.0001	<0.0001	<0.0001	<0.0001	<0.0001	<0.0001	<0.0001	<0.0001	0.001
Cl	80	69	60	52	69	60	52	52	
Co	0.007	0.012	0.014	0.016	0.011	0.012	0.014	<0.001	
Cr <sup>##</sup>	0.006	0.003	0.004	0.004	0.009	0.010	0.012	<0.001	0.01
Cu	0.007	0.009	0.010	0.011	0.010	0.011	0.013	<0.001	0.011
Fe	0.0002	0.0001	0.0002	0.0002	<0.0001	<0.0001	<0.0001	0.057	1
Hg	<0.0001	<0.0001	<0.0001	<0.0001	<0.0001	<0.0001	<0.0001	<0.000001	0.000012
K	1.5	1.8	1.7	1.5	1.8	1.7	1.6	1.6	



	Discharge – Year 0	Discharge – Year 5	Discharge – Year 10	Discharge – Year 15	Discharge – Year 5	Discharge – Year 10	Discharge – Year 15	Discharge – Year 15	Mangatoetoe Receiving Water Quality Standards**
	Scenario C	Scenario D (1)	Scenario E(1)	Scenario F(1)	Scenario D (2)	Scenario E(2)	Scenario F(2)	Scenario F(3)	Hardness
Mg	3.1	4.3	4.6	5.0	3.8	3.9	4.2	4.2	
Mn	0.13	0.42	0.48	0.56	0.20	0.21	0.23	0.23	2
N	0.48	0.41	0.36	0.32	0.42	0.37	0.33	0.33	
Na	18	38	42	45	21	21	20	20	
Ni	0.015	0.027	0.031	0.034	0.022	0.025	0.028	<0.001	0.16
P	0.061	0.027	0.028	0.029	0.085	0.102	0.118	<0.001	
Pb	<0.0001	<0.0001	<0.0001	<0.0001	<0.0001	<0.0001	<0.0001	<0.0001	0.0025
S	56	98	112	127	88	99	112	86	
Sb	<0.001	<0.001	<0.001	<0.001	<0.001	<0.001	<0.001	<0.001	
Se	<0.001	<0.001	<0.001	<0.001	<0.001	<0.001	<0.001	<0.001	0.02
Si	8.9	7.8	7.0	6.1	7.8	6.9	6.1	6.1	
Zn	0.018	0.017	0.020	0.022	0.028	0.033	0.038	<0.001	0.1
TDS (Calculated)	135	195	207	220	216	219	225	153	
Hardness (mg/L CaCO <sub>3</sub> )	145	138	126	117	233	220	210	119	

\*All results reported in mg/L except pH (pH units)

\*\*The receiving water quality standards are hardness dependant and allow for an appropriate dilution following discharge. The standards given assume a hardness of 100 mg/L and are provided here as reference only.

#Detection limit of raw data is higher than receiving water quality standard

## Modelled concentrations are based on Cr(III) and Cr(VI). Receiving water standard is based on toxic form only (Cr(VI)).

## 4.0 Conclusions

The proposed management strategy exists of amendment of the Ohinemuri Diversion during filling with limestone and the active treatment of lake water via dosing with limestone. These measures will ensure that sufficient alkalinity to buffer against the acidity load from the pit walls is available within the pit lake and that discharge water quality to the Managatoetoe Stream meets the receiving water quality criteria specified in the existing discharge consent held by OGNZL.

Reduction in acidity sources from the pit walls – through either active measures such as pit wall amendment, runoff diversion and amendment, etc. or natural weathering, will reduce the reliance on active treatment of the lake water in the long term.

Geochemical modelling shows that the proposed measures will be effective and in line with the pit lake management objectives.

## 5.0 References

AECOM 2018. Project Martha Geochemical Assessment. May 2018

GHD 2018. Project Martha – Water Management, May 2018

HydroNumerics, 2018. Martha Phase 4 Pit Extension – Pit Lake Limnology.

Skousen, J., Zipper, C., Ziemkiewicz, P., Nairn, R., McDonald, L., Kleinmann, R. 2017. Review of Passive Systems for Acid Mine Drainage Treatment. Mine Water and the Environment, March 2017, Vol. 36, Issue 1, pg 133-153.

## 6.0 Limitations

AECOM New Zealand Ltd (AECOM) has prepared this report in accordance with the usual care and thoroughness of the consulting profession for the use of Oceana Gold and only those third parties who have been authorised in writing by AECOM to rely on this Report.

It is based on generally accepted practices and standards at the time it was prepared. No other warranty, expressed or implied, is made as to the professional advice included in this Report.

It is prepared in accordance with the scope of work and for the purpose outlined in the contract dated 19<sup>th</sup> May 2017.

Where this Report indicates that information has been provided to AECOM by third parties, AECOM has made no independent verification of this information except as expressly stated in the Report. AECOM assumes no liability for any inaccuracies in or omissions to that information.

This Report was prepared between 19<sup>th</sup> of January 2018 and the 25<sup>th</sup> of May 2018 and is based on the conditions encountered and information reviewed at the time of preparation. AECOM disclaims responsibility for any changes that may have occurred after this time.

This Report should be read in full. No responsibility is accepted for use of any part of this report in any other context or for any other purpose or by third parties. This Report does not purport to give legal advice. Legal advice can only be given by qualified legal practitioners.

Except as required by law, no third party may use or rely on this Report unless otherwise agreed by AECOM in writing. Where such agreement is provided, AECOM will provide a letter of reliance to the agreed third party in the form required by AECOM.

To the extent permitted by law, AECOM expressly disclaims and excludes liability for any loss, damage, cost or expenses suffered by any third party relating to or resulting from the use of, or reliance on, any information contained in this Report. AECOM does not admit that any action, liability or claim may exist or be available to any third party.

Except as specifically stated in this section, AECOM does not authorise the use of this Report by any third party.

It is the responsibility of third parties to independently make inquiries or seek advice in relation to their particular requirements and proposed use of the site.

Any estimates of potential costs which have been provided are presented as estimates only as at the date of the Report. Any cost estimates that have been provided may therefore vary from actual costs at the time of expenditure.



# Appendix A

## Water Quality Inputs

## Appendix A Water Quality Inputs

	Groundwater					Rainfall	Ohinemuri River				
Sample Collection Dates	10/08/1980	-	08/04/2011				24/01/2000	-	07/10/2015		
Sample Count	381					-	629				
	Min	25th %ile	Median	75th %ile	Max	Theoretical	Min	25th %ile	Median	75th %ile	Max
<b>Cations</b>											
Sodium-Dissolved (g/m3)	4	42	46	50	71	0.95	3	9	9	10	45
Potassium-Dissolved (g/m3)	7	9	9	10	15	0.14	2	2	2	3	10
Calcium-Dissolved (g/m3)	37	344	370	392	698	0.02	1	3	3	4	430
Magnesium-Dissolved (g/m3)	7	84	90	96	142	0.05	0.57	1.71	1.87	2.00	97
Aluminium-Dissolved (g/m3)	0.001	0.003	0.01	0.01	0.11	<0.0001	0.01	0.02	0.03	0.08	0.55
Iron-Dissolved (g/m3)	0.003	0.04	0.40	2.23	224	<0.0001	0.04	0.07	0.11	0.16	1.52
Manganese-Dissolved (g/m3)	0.023	10	11	13	119	<0.0001	0.004	0.01	0.01	0.02	13
Copper-Dissolved (g/m3)	0.0004	0.001	0.001	0.004	0.01	<0.0001	<0.001	<0.001	<0.001	<0.001	<0.001
Zinc-Dissolved (g/m3)	0.004	0.07	0.14	0.23	27	<0.0001	0.001	0.001	0.002	0.004	0.111
Nitrogen-Total Ammoniacal (g/m3)	0.010	0.10	0.13	0.18	1.30	<0.0001	0.01	0.01	0.01	0.02	1.40
Arsenic-Dissolved (g/m3)	<0.001	0.01	0.01	0.02	0.07	<0.0001	<0.001	<0.001	<0.001	<0.001	<0.001
Antimony-Dissolved (g/m3)	0.0002	0.0002	0.0003	0.0004	0.010	<0.0001	<0.001	<0.001	<0.001	<0.001	0.009
Tin-Dissolved (g/m3)	<0.001	<0.001	<0.001	<0.001	<0.001	<0.0001	<0.001	<0.001	<0.001	<0.001	<0.001
Cadmium-Dissolved (g/m3)	<0.0001	<0.0001	0.0002	0.0007	0.01	<0.0001	<0.001	<0.001	<0.001	<0.001	<0.001
Chromium-Dissolved (g/m3)	<0.0002	<0.0002	<0.0002	0.0010	0.01	<0.0001	<0.001	<0.001	<0.001	<0.001	<0.001
Cobalt-Dissolved (g/m3)	0.0029	0.01	0.01	0.01	0.18	<0.0001	<0.0002	<0.0002	<0.0002	<0.0002	<0.0002
Lead-Dissolved (g/m3)	<0.0001	<0.0001	0.0002	0.0006	0.01	<0.0001	<0.0001	<0.0001	<0.0001	<0.0001	0.0080
Nickel-Dissolved (g/m3)	0.016	0.02	0.03	0.04	0.04	<0.0001	<0.001	<0.001	<0.001	<0.001	<0.001
Mercury-Total (g/m3)	<0.0001	<0.0001	<0.0001	<0.0001	<0.0001	<0.0001	<0.0001	<0.0001	<0.0001	<0.0001	<0.0001
<b>Anions</b>											
Bicarbonate (g/m3 at 25°C)	118	147	171	210	210	1.01	8	13	16	20	34
Chloride (g/m3)	<3	11	12	13	36	0.75	5	13	13	13	17
Sulphate (g/m3)	9.60	1,180.00	1,230	1,300	1,870	0.39	<5	4	5	7	1,,300
Selenium-Dissolved (g/m3)	<0.001	<0.001	<0.001	<0.001	0.01	<0.0001	<0.001	<0.001	<0.001	<0.001	0.003
Nitrate-N + Nitrite-N (g/m3)	0.01	0.03	0.07	0.25	0.25	0.04	0.007	0.3	0.5	0.87	1.44
Phosphorus-Total (g/m3)	0.01	0.01	0.01	0.01	0.01	0.00	0.004	0.01	0.02	0.02	0.68
<b>Properties</b>											
Silicon dioxide (g/m3)	40	43	44	45	45	<0.0001	2	20	22	25	29
pH (pH units)	3	6	7	7	8	5.80	5	7	7	7	9
Electrical Conductivity (EC) (mS/m)	15	211	222	231	298	0.40	3	8	9	9	238
Alkalinity-Total (g/m3 as CaCO3)	3	143	160	171	1530	0.83	2	10	14	17	275

Sample Collection Dates	Pit Wall Run-On														
	Post Mineralisation Association					Oxidised Association					Partially Oxidised PAF North Wall				
	6/03/2008	-	17/04/2014	6/03/2008	-	15/05/2015	15/11/2004	-	15/05/2015						
Sample Count	81					193					140				
	Min	25th %ile	Median	75th %ile	Max	Min	25th %ile	Median	75th %ile	Max	Min	25th %ile	Median	75th %ile	Max
<b>Cations</b>															
Sodium-Dissolved (g/m3)	1	3	4	5	9	1	3	4	7	31	0	2	3	5	13
Potassium-Dissolved (g/m3)	1	1	2	4	18	0	0	1	3	164	<0.1	0.1	0.2	1	4
Calcium-Dissolved (g/m3)	1	3	5	9	25	0	1	1	3	80	<1	29	84	244	669
Magnesium-Dissolved (g/m3)	0.27	1.20	2.25	3	12	0.20	0.45	0.67	1	6	<1	46.30	83.70	152	299
Aluminium-Dissolved (g/m3)	0.03	0.13	0.18	0.30	0.66	0.01	0.03	0.06	0.14	0.81	1	1	1	1	1
Iron-Dissolved (g/m3)	<0.02	0.04	0.10	0.18	0.92	<0.02	0.03	0.05	0.08	0.88	<0.02	28	87	339	1520
Manganese-Dissolved (g/m3)	0.005	0.05	0.09	0.4	1.5	0.001	0.004	0.04	0.1	0.6	0.000	8	13	22	48.2
Copper-Dissolved (g/m3)	<0.0005	0.001	0.001	0.002	0.006	<0.001	<0.001	<0.001	0.002	0.021	<0.0005	0.15	0.26	0.58	1.230
Zinc-Dissolved (g/m3)	0.003	0.007	0.011	0.026	0.10	0.001	0.004	0.006	0.008	0.06	<0.001	0.23	0.49	1.3	3.8
Nitrogen-Total Ammoniacal (g/m3)	<0.01	0.01	0.01	0.04	3.1	<0.01	<0.01	<0.01	0.02	26	0.00	0.01	0.02	0.10	1.1
Arsenic-Dissolved (g/m3)	<0.001	<0.001	<0.001	<0.001	<0.001	<0.001	<0.001	<0.001	<0.001	0.022	0.000	0.002	0.009	0.069	0.840
Antimony-Dissolved (g/m3)	<0.0002	<0.0002	<0.0002	<0.0002	<0.0002	<0.0004	<0.0002	0.0002	0.0002	0.0091	<0.0002	0.0002	0.0003	0.0004	0.0110
Tin-Dissolved (g/m3)	<0.001	<0.001	0.001	0.001	0.001	<0.001	<0.001	<0.001	<0.001	<0.001	0.001	0.001	0.001	0.001	0.001
Cadmium-Dissolved (g/m3)	0.000	0.000	0.000	0.000	0.001	<0.001	<0.001	<0.001	<0.001	0.002	<0.0001	0.001	0.002	0.003	0.011
Chromium-Dissolved (g/m3)	<0.001	<0.001	<0.001	<0.001	0.140	<0.001	<0.001	<0.001	<0.001	0.017	0.000	0.042	0.084	0.179	0.608
Cobalt-Dissolved (g/m3)	<0.0002	0.0003	0.0008	0.0036	0.0530	<0.0002	0.0002	0.0003	0.0007	0.0100	0.0008	0.2	0.4	0.7	1.6
Lead-Dissolved (g/m3)	<0.0001	0.0001	0.0001	0.0002	0.0024	<0.0001	<0.0001	<0.0001	0.0002	0.0007	<0.0001	0.0002	0.0006	0.003	0.08
Sodium-Dissolved (g/m3)	<0.0005	0.001	0.002	0.006	0.044	<0.0005	<0.001	<0.001	<0.001	0.010	<0.0005	0.6	0.9	1.7	3.7
Mercury-Total (g/m3)	<0.0001	<0.0001	<0.0001	0.0004	0.0028	<0.0001	<0.0001	<0.0001	<0.0001	0.0003	<0.0001	<0.0001	<0.0001	0.0002	0.02
<b>Anions</b>															
Bicarbonate (g/m3 at 25°C)	3	5	5	6	12	1	4	6	9	40	<0.01	<0.01	<0.01	<0.01	<0.01
Chloride (g/m3)	2	6	8	10	39	1	5	8	13	240	0	3	5	8	22
Sulphate (g/m3)	1	8	16	34	105	1	3	5	7	143	0	1,130	2,970	5,905	52,400
Selenium-Dissolved (g/m3)	<0.001	<0.001	<0.001	<0.001	<0.001	<0.002	<0.001	0.001	0.001	0.004	<0.001	0.002	0.003	0.006	0.014
Nitrate-N + Nitrite-N (g/m3)	<0.02	0.01	0.02	0.05	0.320	<0.2	0.01	0.02	0.05	0.80	0.0	0.00	0.00	0.02	0.680
Phosphorus-Total (g/m3)	0.03	0.09	0.15	0.24	1.670	0.01	0.03	0.05	0.26	20	0.00	0.00	0.00	0.00	0.000
<b>Properties</b>															
Silicon dioxide (g/m3)	3	7	7	10	26	1	1	2	2	6	5	12	18	24	44
pH (pH units)	4	6	6	6	7	4	5	6	6	8	2	3	3	3	8
Electrical Conductivity (EC) (mS/m)	1	6	9	13	31	1	3	5	8	118	<1	91	170	270	899
Alkalinity-Total (g/m3 as CaCO3)	<2	3	4	6	53	<2	2	3	5	120	<1	1	1	1	135

	Pit Wall Run-On									
	Chlorite - Calcite					Fresh PAF South Wall				
Sample Collection Dates	12/07/2008	-	16/03/2015			16/06/2008	-	17/06/2014		
Sample Count	31					59				
	Min	25th %ile	Median	75th %ile	Max	Min	25th %ile	Median	75th %ile	Max
<b>Cations</b>										
Sodium-Dissolved (g/m3)	2	4	4	5	6	0.2	1	2	4	23
Potassium-Dissolved (g/m3)	0.4	0.5	1	1	1	<0.1	0.1	0.3	0.4	6
Calcium-Dissolved (g/m3)	21	61	107	153	450	2	12	34	95	570
Magnesium-Dissolved (g/m3)	2	3	5	9	13	3	20	59	133	670
Aluminium-Dissolved (g/m3)	1	23	28	32	50	18	75	125	190	400
Iron-Dissolved (g/m3)	0.02	0.02	0.02	0.02	0.10	1.10	58	430	1,100	3,600
Manganese-Dissolved (g/m3)	0.0000	0.01	0.01	0.02	0.1	0.034	1.02	2.35	6.4	38.0
Copper-Dissolved (g/m3)	0.001	<0.001	0.001	0.001	0.002	0.002	0.1	0.3	0.7	3.2
Zinc-Dissolved (g/m3)	0.003	0.003	0.006	0.008	0.01	0.042	0.260	0.98	1.9	7.5
Nitrogen-Total Ammoniacal (g/m3)	0.00	0.01	0.02	0.02	0.2	<5	0.02	0.10	0.46	10.0
Arsenic-Dissolved (g/m3)	<0.001	<0.001	<0.001	0.002	0.002	<0.001	0.006	0.146	0.480	4.2
Antimony-Dissolved (g/m3)	0.0002	0.0002	0.0002	0.0003	0.0004	<0.001	<0.0002	0.0005	0.0010	0.016
Tin-Dissolved (g/m3)	<0.001	<0.001	<0.001	<0.001	<0.001	<0.0025	<0.0005	0.001	0.003	0.005
Cadmium-Dissolved (g/m3)	<0.0001	<0.0001	<0.0001	<0.0001	<0.0001	<0.0001	0.000	0.002	0.004	0.013
Chromium-Dissolved (g/m3)	<0.001	<0.001	<0.001	<0.001	0.003	0.001	0.067	0.335	0.783	1.800
Cobalt-Dissolved (g/m3)	0.0002	0.0002	0.0002	0.0002	0.001	0.0110	0.1	0.3	0.8	1.5
Lead-Dissolved (g/m3)	<0.0001	<0.0001	<0.0001	<0.0001	<0.0001	<0.0002	0.0001	0.0003	0.0005	0.0047
Sodium-Dissolved (g/m3)	<0.001	<0.001	<0.001	<0.001	0.003	0.029	0.2	0.7	1.5	3.3
Mercury-Total (g/m3)	<0.0001	<0.0001	<0.0001	<0.0001	0.0002	<0.0001	<0.0001	0.0004	0.0007	0.0037
<b>Anions</b>										
Bicarbonate (g/m3 at 25°C)	<0.01	<0.01	<0.01	<0.01	<0.01	1	1	1	1	1
Chloride (g/m3)	1	4	5	9	33	1	4	6	9	52
Sulphate (g/m3)	48	78	160	240	380	96	840	2,500	6,600	17,000
Selenium-Dissolved (g/m3)	0.001	0.001	0.001	0.001	0.005	<0.002	0.001	0.008	0.021	0.120
Nitrate-N + Nitrite-N (g/m3)	0.0	0.02	0.03	0.09	0.530	<0.2	0.06	0.20	0.73	14
Phosphorus-Total (g/m3)	0.01	0.02	0.02	0.03	0.080	0.01	0.15	2.80	10.85	65
<b>Properties</b>										
Silicon dioxide (g/m3)	3	4	4	6	19	4	9	13	29	116
pH (pH units)	3	7	7	7	8	2	2	3	3	7
Electrical Conductivity (EC) (mS/m)	17	40	62	83	228	33	176	314	540	1,183
Alkalinity-Total (g/m3 as CaCO3)	20	24	25	32	1	<1	<1	1	1	1



# Appendix B

## Alkalinity Dosing System

Date: 13 October 2011  
To: Charlie Schorr-Kon, Anthony Kirk  
From: Mohammed Aiyaz  
Subject: Martha Pit Alkalinity Dosing System - Mechanical Concept

## **1. Introduction**

As part of Martha Pit remediation (scenario C-2), it has been determined that an annual net alkalinity inflow of 29T would be required to neutralise the water in the pit after it has been filled. It is envisaged that this would be achieved by abstracting and dosing lake water with calcium carbonate ( $\text{CaCO}_3$ ) at a dosed concentration of 0.1%<sup>1</sup>.

It has been assumed that the most effective period for dosing  $\text{CaCO}_3$  or lime would be over the summer months (3 months) when the rainfall run-off flow into the pit will be lower leading to higher acid concentrations when rainfall events do occur.

The volume of lake water required to achieve the required 0.1% lime dilution concentration will be 28,971m<sup>3</sup> per annum. The flowrate based on a 90 day (3 month) and 8 hour per day operation will be 11.2 L/s.

## **2. System Overview**

Dry lime (calcium carbonate) would be provided in the form of ground limestone. This is anticipated to be supplied in bulk into a lime silo (see Figure 2) from where a prescribed quantity would be added via a screw feeder to a batch mixing tank (see Figure 3). The calcium carbonate would then be mixed with a prescribed volume of water to give a known batch concentration of lime slurry (see Figure 4).

The lime slurry would then be dosed at a set rate into a known flowrate of water resulting in final calcium carbonate concentration of 0.1%. This would then be dosed onto the surface of the lake via a floating diffuser arrangement.

In order to facilitate and extend the alkalinity diffusion period and prevent "short circuits", the water intake pipeline and the dosing point will be located on opposite sides of the lake.

## **3. System Details**

### **3.1 Dry Lime**

It is proposed that "Calcimate" which is finely ground limestone be used which is supplied by McDonalds Lime. The annual requirement of 29T would be delivered in bulk 10T batches by road tankers.

---

<sup>1</sup> As per information provided by URS New Zealand Ltd - Auckland Geosciences

## 3.2 Piping System

### 3.2.1 Surface Run Piping

Based on a pipe velocity of 1.5m/s, which would be essential in ensuring that the lime particulates are kept in suspension downstream the dosing point, and a water flowrate of 11.2L/s over the 3 month summer period, the required internal pipe diameter would be 97.5mm.

A 110 OD SDR 17 PE100 pipe (PN10) with a mean internal bore diameter of 96mm would provide a pipe velocity of about 1.55m/s.

The pipe length from the pump well to the dosing point over the lake is estimated to be 1500m and the expected line pressure loss over the pipe length will be in the vicinity of 30m.

The pipe is expected to run along the existing bench at an elevation of approximately RL +1120 or at a lower level where the pipe will not be inundated. Posts embedded in the ground at intervals along the length of the pipe from moving from the bench (see Figure 2 below).

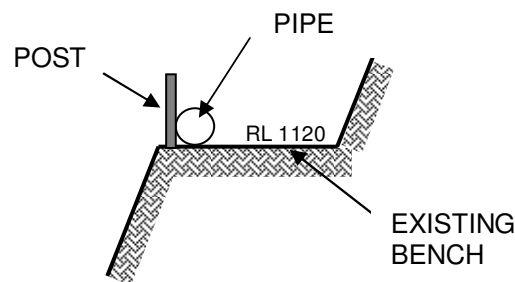

**Fig 2** Proposed Pipe Arrangement

An alternative option would be to utilise the existing mine dewatering pipework which is currently being used to pump water out of the mine and is routed along the mine periphery. Modifications would be required to accommodate the water supply pump and dosing connections. Also, the relatively larger bore of the dewatering pipework (400 OD) would cause potentially low water velocity (about 0.1m/s), implying that the pipeline diameter would need to be reduced to 110 OD prior to and downstream of the dosing point to prevent lime particulates from dropping out of suspension and settling in the pipework.

### 3.2.2 Floating Pipe

It is anticipated that pipe floats and on-shore mooring blocks will be provided to hold the PE pipe in place at the dosing location. The dosed 0.1% solution is expected to discharge at the end of the pipe.

### **3.3 Valves**

Manual ball or gate valves will be provided in the slurry system depending on the extent of flow control required.

A pressure relief valve may be required at the pump to prevent pump damage should the discharge valve be closed or a blockage occurs while the pump is operating.

### **3.4 Water Supply System**

A submersible pump located on a floating pontoon arrangement and connected via floating pipes would be the most economical option. However, this arrangement would make the pump accessibility for maintenance relatively difficult and it may also interfere with potential public water recreational activities if planned in the future.

A submersible pump located within a wet-well would be an alternative option that would occupy a relatively small area. The depth of the wet-well will depend on the level at which the wet-well is located. Given that the elevation of water in the lake is expected to be RL +1104 and the next available bench is at elevation RL +1120, the likely depth of a wet-well will be about 18m. However, this can be reduced by locating the wet-well on a new bench cut into the existing slope closer to the water level.

The flow requirement of the pump is estimated to be 11.2L/s at a duty head of about 50m. It is anticipated that the pump would be selected based on hydraulic calculations carried out at the time of the system design and that the water pump would be operating on a fixed speed basis.

In order to provide accurate flowrates, a flow meter will be required in the line to provide a control signal to the dosing pump.

### **3.5 Lime Storage**

It is proposed that lime be procured in bulk and stored in a lime storage bin. The size of the lime silo would be dictated by the minimum load size provided by the lime supplier via their road delivery bulk tankers, which is typically 10T. This implies that, based on an annual lime consumption of 29T, three deliveries would be required over the dosing period.

Given the mildly hygroscopic nature of calcium carbonate, which could cause it to cake after absorbing moisture and bridge the bottom of the silo, it would be prudent to ensure that the lime silo is left empty between the annual dosing cycles.

Bulk lime would be pneumatically conveyed into the silo using the on-board system available on the road tankers. An adequately sized silo vent and filter system would be required to contain the lime dust generated during the lime transfer.

A screw feeder system with a weighing capacity would be required to deliver the prescribed lime mass required for a batch from the lime silo to a lime mixing system. A rotary valve would be required at the bottom of the silo to prevent ingress of moisture. The proposed arrangement of the lime silo is shown in Figure 3 below.

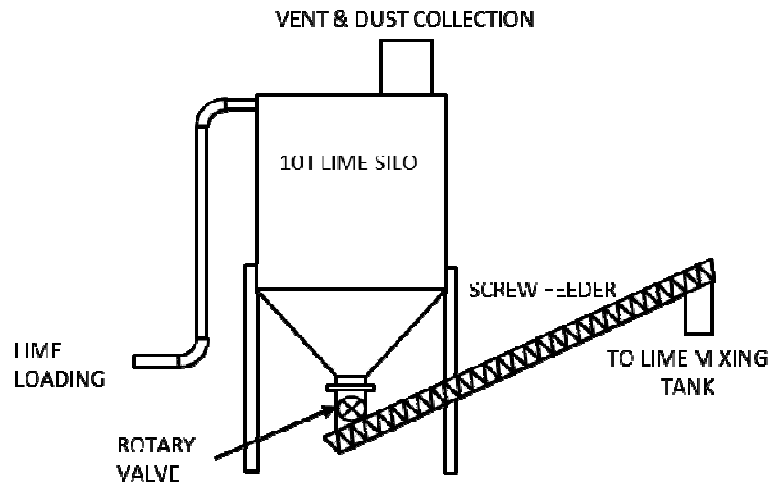

**Fig. 3** Proposed Lime Silo Arrangement

### 3.6 Lime Mixing System

A suitably sized lime mixing tank would be required which would likely consist of a stainless tank with an agitating/mixing assembly. This would operate as a batch process and would contain a known concentration of lime slurry. In order to ensure optimum viscosity for pumping and reduce particulate settlement, the lime concentration would typically be 30% by weight.

Based a 90 day dosing period, the daily Calcimate demand would be approximately 322kg. The corresponding water mass required to provide the required 30% concentration would 751kg which equates to a volume of 0.751m<sup>3</sup>. Therefore, the total working volume required for a daily batch lime mixing tank would be approximately 0.98m<sup>3</sup>.

A possible tank arrangement for this volume is depicted in Figure 4 below. It should be noted that the size of the vessel is dependent on the batch requirements and could be increased to cater for batch frequencies of more than a day.

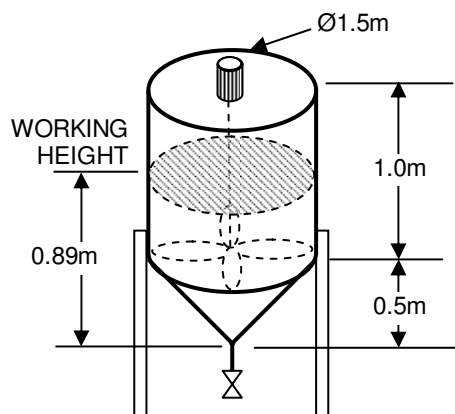

**Fig. 4** Lime Mixing Tank for Daily Demand Batching

The mass of lime required for a batch would be added by the lime silo screw feeder. This would be mixed with a known volume of water to provide the correct slurry concentration. Continuous mixing would be necessary whilst there is lime slurry in the tank as this would prevent lime particulates from settling in the tank.

It is proposed that the lime mixing plant be enclosed in a building which would protect the equipment from the elements and against theft and vandalism. A pre-fabricated steel structure with cladding and a concrete floor would provide an economical option.

Adequate ventilation would be needed to ensure prompt dispersion of any lime dust within the confines of the building.

### **3.7 Lime Slurry Pump**

A peristaltic pump is suggested to provide a fixed and controllable rate of slurry supply into a known flow of water. The pump would be controlled by the flow of water in the main pipeline via a control signal from the flowmeter.

Based on a slurry concentration of 30%, the expected daily dosing rate is calculated to be 0.034L/s or about 123 L/hr.

### **3.8 Electrical**

Electrical supply would be required for the pumps, silo and mixing tank equipment.

It is estimated that the power consumption will be in the vicinity of 30kW and it is expected that this would be provided by the mains electrical power available on site.

Suitable lighting and other services may be required around the pump station and dosing facilities.

### **3.9 pH Control and Automation**

Generally it is possible to produce inputs to a control system from any measurable parameter. It would be possible to initiate dosing of calcium carbonate solution to the lake based on the in-line monitoring of the lake water pH. Either a submersible pH instrument or a dry mounted analyser situated close to the lake out flow location, such as at the dosing water supply pump station would be required for this purpose.

Whether this is suitable for the control of the specific system depends on numerous factors. Due to a number of factors as noted below, it would not be prudent to automate the lake dosing system.

Factors that limit the ability to automate the alkalinity dosing to the Martha Pit lake:

- The Martha Pit lake would be an extremely large volume of water, hence any bulk changes in lake chemistry would take place over a long period of time;
- Detection of changes in lake chemistry may come too late and the effect of dosing to the lake would have a long lag-time in terms of changes at the instrumentation;
- Due to the lake dynamics being currently unknown the location of any instrument(s), may not provide a good real-time picture of the lake chemistry;

- It is important to gain an understanding of the lake characteristics and dynamics once the lake is established, through regular sampling of the lake body. These samples would provide a good picture of the lake chemistry on an ongoing basis and would negate the need for an automated system.

URS would not recommend automation of the dosing system. It would be possible, however, to install a supervisory control and data acquisition (SCADA) system to control the dosing system via telemetry, (i.e. manual control from an internet terminal, etc). Implementation of this type of controls would increase the cost of the installation.

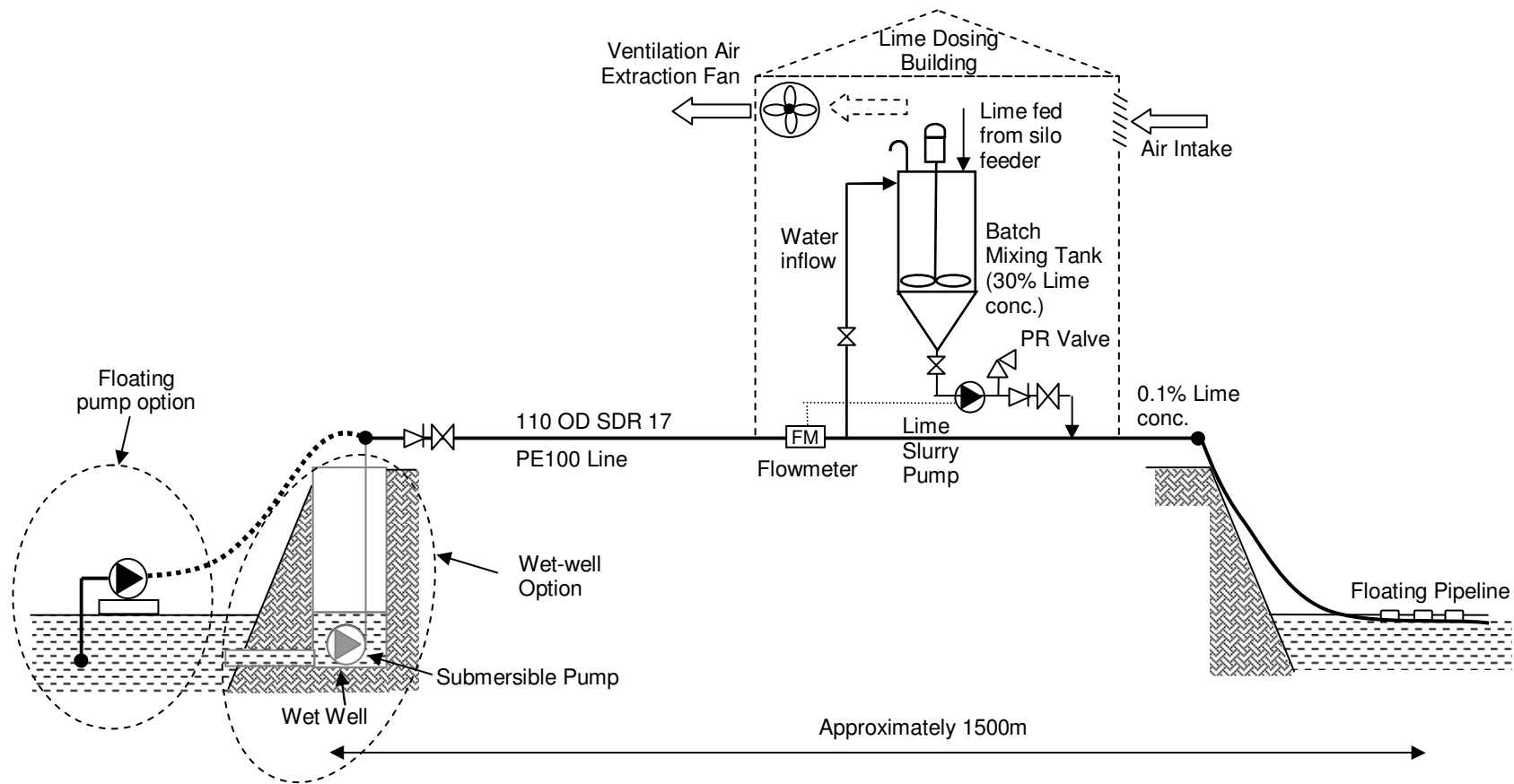

**Fig 1** Schematic of Proposed System